



RapID Lab

Automated Lab Animal ID



RapID Tag™ Product Guide



RapID Tag™ Product Guide

The RapID Tag System has been designed to provide safe, humane, automated tracking and data collection for small laboratory animals.

This Product Guide provides a detailed description of RapID Tags and the easy-to-use precision hand-tools utilized in their application and removal. In order to obtain the best performance from the RapID Tag System, the instructions in this Guide must be followed precisely.

For the most up to date training and product information, please visit: www.rapidlab.com/support

Contents:

RapID Tags – Product Overview	2
RapID Tag Starter Kit - Description	3
RapID Applicator - Description.....	4
RapID Removal Tool - Description	5
Introducing the RapID Tag into Your Facility	6
RapID Tag Self-Certification	7
Loading the RapID Applicator	8
Applying RapID Tags.....	9
Scanning RapID Tags	10
Removing RapID Tags.....	11
RapID Tag Support	12

RapID Tags – Product Overview

RapID Tag’s unique design encapsulates a hardened metal barcode in a tough, chew-resistant, medical-grade, advanced polymer body. The virtually indestructible, scratch-resistant barcode contains an exclusive combination of alpha-numeric characters providing the lab technician with millions of unique ID numbers.

Multi-colored RapID Tags also provide ultra-fast (secondary) visual identification without disturbing caged animals. RapID Tags can be auto-matched to computer-generated, colored cage-card labels using our exclusive website application.



RapID Tags are ordered and shipped in five different colors – 20% of each color. Each box of RapID Tags contains 200 tags (40 tags of each color).

- Caution -



Do not reuse RapID Tags

Autoclave RapID Tags up to 25 minutes at 121°C

Store RapID Tags between 60-85°F (15-26°C)

RapID Tag Starter Kit - Description

The RapID Tag Starter Kit includes everything required to easily and quickly apply and remove RapID Tags. The kit contains the following components:



Starter Kit Contents:

200 RapID Tags
(10 trays)

20 RapID Practice Tags
(1 tray)



1 RapID Applicator



1 RapID Removal Tool

RapID Applicator - Description

The RapID Applicator is a precision, custom hand-tool designed to remove the RapID Tag from the tray and apply the tag to the animal's ear.

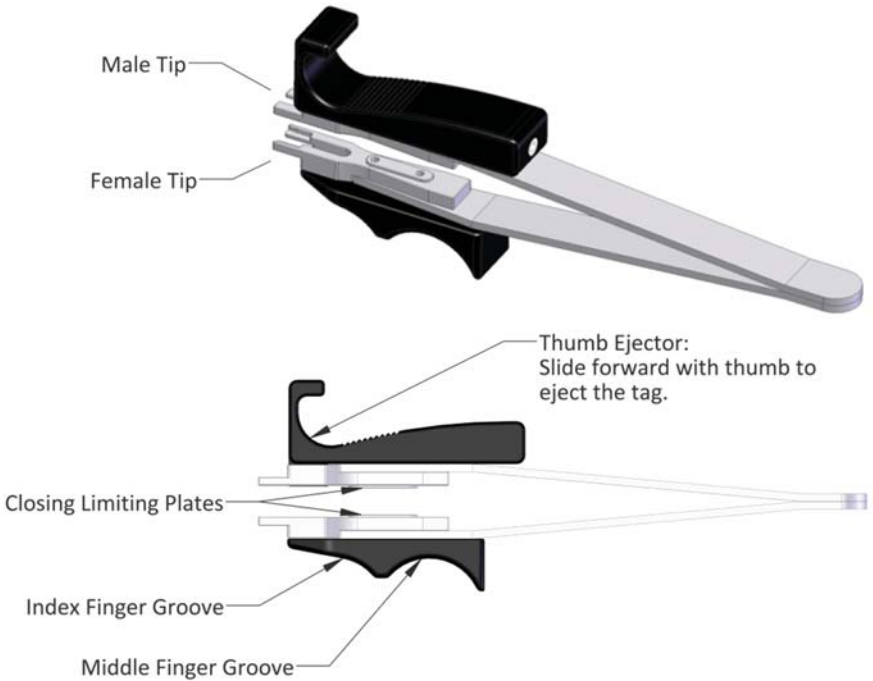

Materials: Stainless Steel & Acetal.
All Components are autoclave safe
at 121 degrees Celcius

RapID Removal Tool - Description

The RapID Removal Tool is a precision, hand-tool that easily and quickly removes the RapID Tag from the animal's ear painlessly, and without any ear deformation.

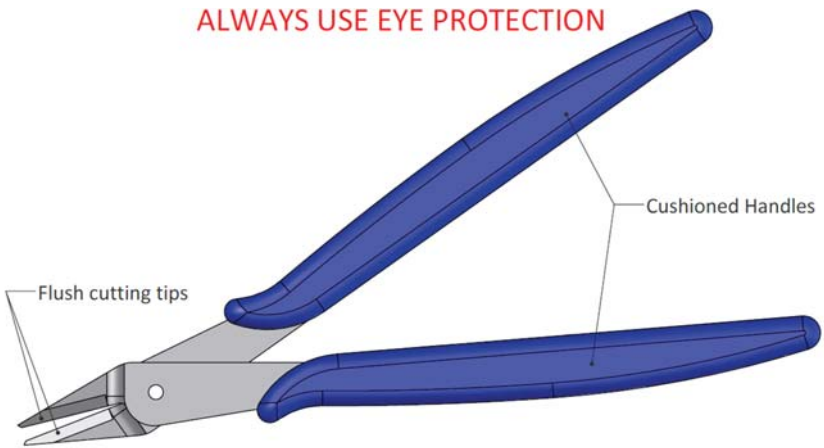

Removal tool is not intended for autoclave
but may be disinfected with alcohol.

Introducing the RapID Tag into Your Facility

As with any new procedure, product, or technique, certain steps must be taken to ensure successful introduction into a facility. Correctly training personnel will ensure the most successful and humane implementation possible. RapID Lab recommends the following protocol for successful introduction into a facility:

1. Select 1 or 2 users who will be using the product on a regular basis and wish to initially become the resident RapID Tag experts. These users should be technicians or investigators who have extensive experience with lab mice, strong hand-eye coordination, excellent manual dexterity, and previous ear notching/tagging experience. Once selected, these users must perform the RapID Tag Self-Certification found in the following section of this guide. Once self-certified, please see step 2 below.
2. For optimal training confirmation, initially conduct a small study with 10-20 animals of the same strain to ensure the animals tolerate the tags well. Observe the following guidelines:
 - a. Mice must be housed no more than 5 mice to a cage.
 - b. On the initial study, mice should ideally be housed together for at least 7 days to acclimate and establish the social hierarchy within the cage *before* tagging to minimize infighting and potential tag tear-out. This may not always be possible on other, more routine studies, but is a recommended practice whenever possible.
 - c. RapID Tags may sometimes become caught on some types of enrichment (such as tubes, mesh, hard metal or plastic structures, etc...) and be accidentally torn out of the animal's ear. Hard, metal or plastic structure types of enrichment should be minimized or eliminated altogether on the initial study when introducing the RapID Tag. Once the facility has successfully implemented the RapID Tag, users may slowly and systematically introduce enrichment products.
 - d. During the initial study, users should envision and brainstorm ways that the RapID Tag can save time and reduce errors when administering injections, observing animals, taking census data, etc...
 - e. Users should practice identifying and scanning animals using the scanner several times per week. Ensure that the scanner is working correctly with the software you intend on using throughout your research.
3. Once the study has been successfully completed, the facility may adopt RapID Tags for larger scale studies and may also appoint the initial users as the resident experts for RapID Tags and allow them to train others on the proper use and implementation of the RapID Tags.

RapID Tag Self-Certification

The RapID Tag Starter Kit comes with practice material that simulates the animal's ear to allow users to self-certify with the RapID Tag System prior to working with live laboratory animals. RapID Lab recommends the following protocol for self-certification:

1. The user should read and understand this entire Product Guide to become familiar with the proper operation and use of the RapID Tag products.
2. The user should practice loading the RapID Applicator and applying RapID Tags to the simulated ear material; then practice removing the tags from the practice material. Each time, the user should carefully follow the step-by-step directions contained in the following sections of this Guide which are related to the skill which they are practicing.
3. Once a user feels comfortable, they should perform a consecutive number of loadings, applications, and removals to ensure they are able to consistently perform these critical steps correctly.
4. Users should be able to load, apply, and remove 5 tags consecutively in the supplied ear simulation material without any *incident* prior to considering themselves certified and ready for using RapID Tags with live laboratory animals.
5. Incidents include, but are not limited to:
 - a. Mis-loading the applicator.
 - b. Tearing of the simulated ear material during application.
 - c. Incorrect, mis-connection or mis-alignment of the RapID Tag during application.
 - d. Problems ejecting the applied RapID Tag from the applicator.
 - e. Tearing of the simulated ear material during removal.
6. Facility managers may choose to provide an additional layer of user certification for applying and removing RapID Tags to live animals. Although the removal and application process is exactly the same, additional variables will include properly restraining the animal and making certain that the RapID Tag was correctly positioned on the animal's ear as described in the following sections of this Guide.

Loading the Rapid Applicator

Holding the applicator in your dominant hand and the tray in your non-dominant hand:

1. **Position**, then gently **close**, the tips of the applicator onto the edge of the tag.
2. **Pushing with your palm**, **slide** the applicator onto the tag **until snug** (approximately $\frac{3}{4}$ of the way onto the tag).
3. **Using your thumb**, **lift** the male half of the tag up and out of the tray.
4. **Slide** the female half of the tag out of the tray and verify alignment with the male half.

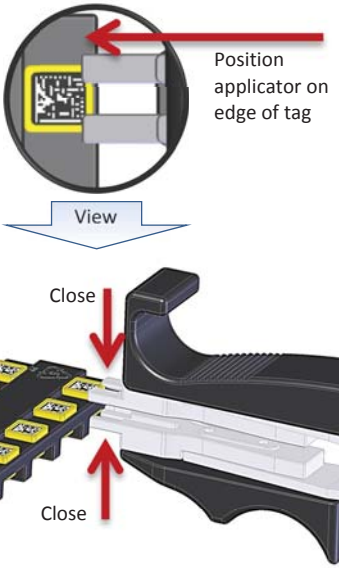
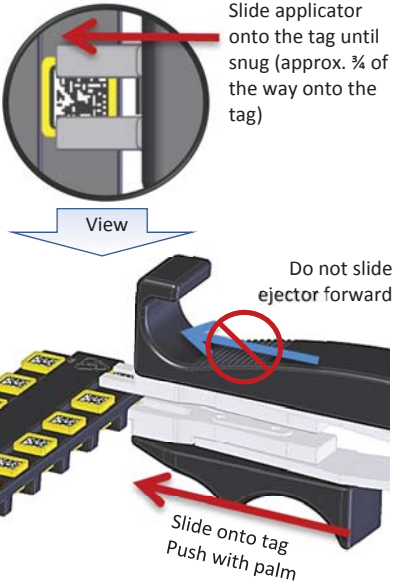
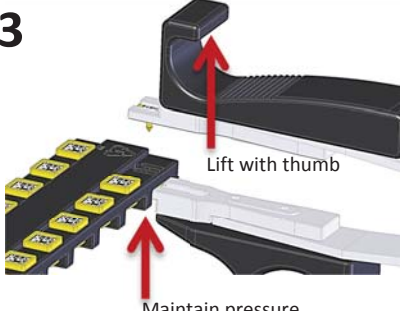
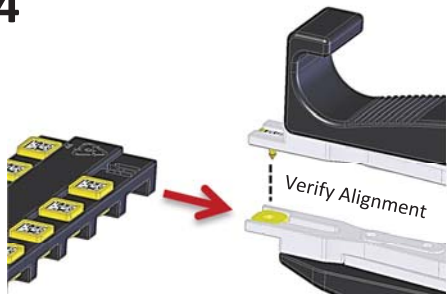
<p>1</p>  <p>Position applicator on edge of tag</p> <p>View</p> <p>Close</p> <p>Close</p> <p>Gently position the tips of the applicator onto the edge of the male & female halves of the tag, then close with moderate pressure.</p>	<p>2</p>  <p>Slide applicator onto the tag until snug (approx. $\frac{3}{4}$ of the way onto the tag)</p> <p>View</p> <p>Do not slide ejector forward</p> <p>Slide onto tag Push with palm</p> <p>Maintaining moderate closing pressure, slide the applicator onto the tag until snug (approx. $\frac{3}{4}$ of the way onto the tag). Do not slide the ejector forward.</p>
<p>3</p>  <p>Lift with thumb</p> <p>Maintain pressure</p> <p>Maintaining pressure on the bottom (female) half of the tag, lift the male half up and out of the tray with your thumb.</p>	<p>4</p>  <p>Verify Alignment</p> <p>Carefully slide the female half straight out of the tray and verify the male and female tags are aligned. Manually align with finger, if required.</p>

Applying RapID Tags

To apply the RapID Tag onto the animal's ear using the RapID Applicator:

1. Ensure that the applicator is loaded correctly with the male and female halves of the tag properly aligned. Securely restrain the lab animal with your non-dominant hand. Using your dominant hand, hold the loaded applicator with the thumb-side (barcode side) facing you and **locate** the applicator near the inside of the ear.
2. **Position** the male applicator tip onto the ear such that the barcode side of the tag is on the inside of the ear within the green target zone. Take care to correctly position the tag as shown in frames 2 & 3 below.
3. With the tag correctly positioned, firmly **press** the applicator closed by squeezing your thumb and **index** finger together. You will hear and feel the tag snap together.
4. Leaving the applicator closed, slide your thumb forward to **eject** the tag while also simultaneously disengaging the applicator from the ear.

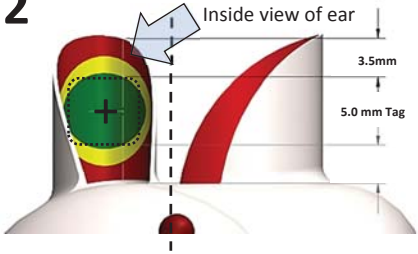
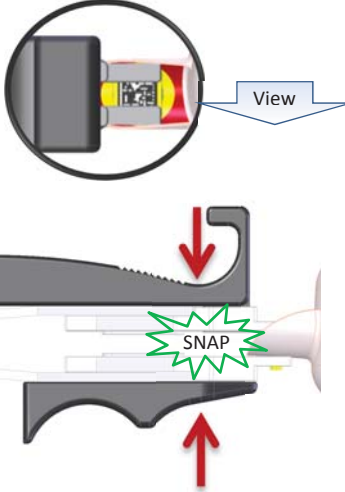
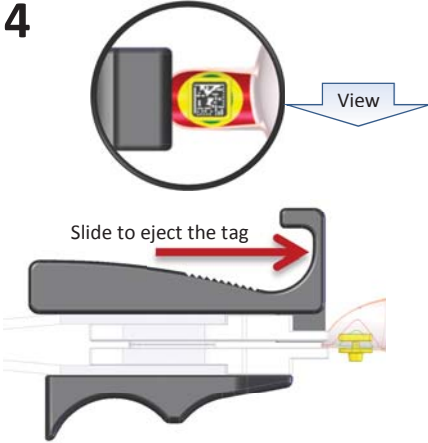
<p>1</p>  <p>Locate the loaded applicator near the inside of the ear, with the male (barcode) half of the tag facing you.</p>	<p>2</p>  <p>Position the male barb near the center of the green zone as shown above to enable easy scanning and maximum durability.</p>
<p>3</p>  <p>With the tag correctly positioned in the green zone, firmly press the applicator closed until it snaps together to secure the tag.</p>	<p>4</p>  <p>Carefully eject the tag from the applicator by sliding the thumb piece forward while disengaging the applicator from the ear.</p>

Scanning RapID Tags

Although RapID Tags work well with most industry scanners certified to read ISO/IEC 16022 Data Matrix Standard Codes, RapID Lab recommends using the Code CR 1400. For best results when scanning please follow the instructions below:

1. Use a scanner stand to free both hands.
2. Restrain the laboratory animal with one hand.
3. Use the other hand to ensure that there is nothing blocking the direct line of sight from the scanner to the RapID Tag barcode. Potential obstructions include fur, tissue, ear folds, etc.
4. Position the applied RapID Tag in the direct line of sight of the scanner and maneuver the tag into the scanner's optimal scanning zone. With the Code CR1400 scanner, use the built in blue targeting lights to find the best tag location for fast scanning.
5. With the applied RapID Tag positioned correctly in the scanner's target zone, the identification 'ping' will be acquired within 1 second.





Code CR 1400 Scanner
(shown with stand)

Removing RapID Tags

To remove the RapID Tag from the animal's ear using the RapID Removal Tool:

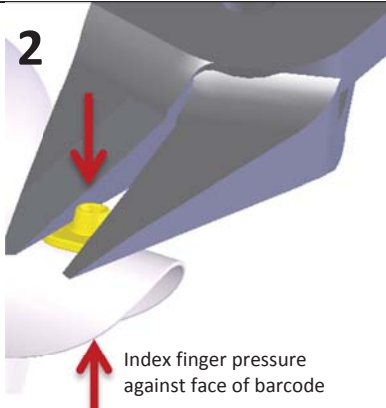
1. **Always use proper eye protection when using the removal tool.**
2. Apply pressure to the male (barcode) side of the tag with your index finger. Holding the removal tool with your other hand, apply equal pressure with the tool to the base of the female side of the tag.
3. Make sure the removal tool is positioned correctly on the tag.
4. Then close the removal tool fully while maintaining pressure thereby cleanly cutting off the female cone. Carefully pull the tag apart, if required.

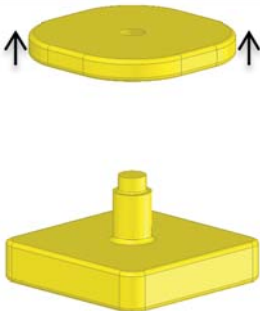
<p>1</p>  <p>Always use eye protection when using the RapID Removal Tool!</p>	<p>2</p>  <p>Index finger pressure against face of barcode</p> <p>To remove the RapID Tag, press the RapID Removal Tool flush against the back of the female tag while applying opposite pressure with your index finger against the male (barcode) half.</p>
<p>3</p>  <p>Make sure the removal tool is positioned correctly as shown in frame #2.</p>	<p>4</p>  <p>Close the removal tool fully, cleanly cutting off the female cone. Carefully pull the tag apart, if required.</p>



RapID Tag Support

Please visit the RapID Lab Website Support Page for more information on the following items:

1. **The latest support documentation** – Available in PDF format for easy download and printing at your facility.
2. **Scanner and software documentation and support** – Documents for setting up the scanner and software.
3. **Free data collection templates** – MS Excel template specifically designed to work with RapID Tags and the Code CR 1400 Scanner.
4. **Our exclusive RapID Label App** – This free web application allows our customers to quickly and easily generate custom color labels that correspond to the animal's ID for labeling cage cards, samples, etc.
5. **PDF of this product guide.**

www.rapidlab.com/support/